

Safety Valves DN65 x DN80



DUCO

Safety Valves DN65 x DN80

Duco safety valves to protect closed heated and chilled water systems against excessive pressure.

Application

The safety valve has to be used in a closed heating or cooling system (glycol max. 50%) Only use the Duco valve in a dry and frostfree location.

Min / max. system temp.: -10°C / +120°C

Safety

Check whether the max. capacity and the opening pressure that are indicated on the valve match the values of the system.

All Duco safety valves meet the requirements of the Pressure Equipment Directive (PED)

“Directive 2014/68/EU Module B/Module D”

The quality system also complies with the NEN-EN-ISO 9001

NORM: NEN-EN-ISO 4126-1

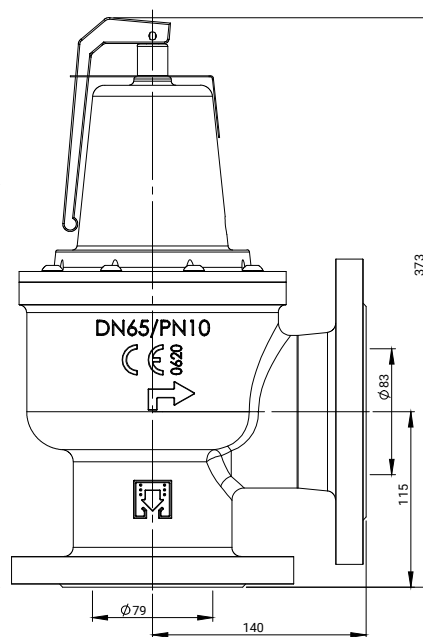

Safety Valves DN65 x DN80

Article number	Set pressure bar	Heating capacity kW
1180-0-01-11	0,5	735
1180-0-02-11	1	1055
1180-0-04-11	2	1525
1180-0-05-11	2,5	1760
1180-0-06-11	3	1980
1180-0-08-11	4	2440
1180-0-10-11	5	2880
1180-0-16-11	6	3305
1180-0-17-11	7	3730
1180-0-18-11	8	4155
1180-0-19-11	9	4580
1180-0-20-11	10	4970



PUCO

PenTec bv
Edisonweg 7
3442 AC Woerden
The Netherlands

Tel. +31 (0)182 503 100
E-mail info@pentecbv.nl
Internet www.duco.nl
www.pentecbv.nl